

Löschgruppenfahrzeug Katastrophenschutz
 MAN TGM 18.340
 Erstellt für das
 Bundesamt für Bevölkerungsschutz und Katastrophenhilfe (BBK)
 Provinzialstraße 93, 53127 Bonn

www.bbk.bund.de

Vervielfältigungen oder Änderungen sind nur mit der Zustimmung des BBK gestattet.

Design: Volker Preikschat

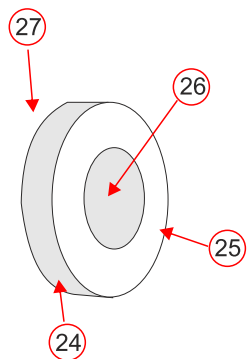
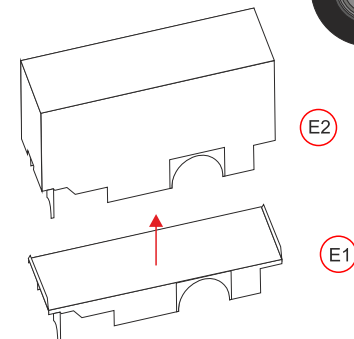

LF-KatS
 (C) 04/2014 Bundesamt für
 Bevölkerungsschutz
 und Katastrophenhilfe (BBK)
 Design: V.Preikschat

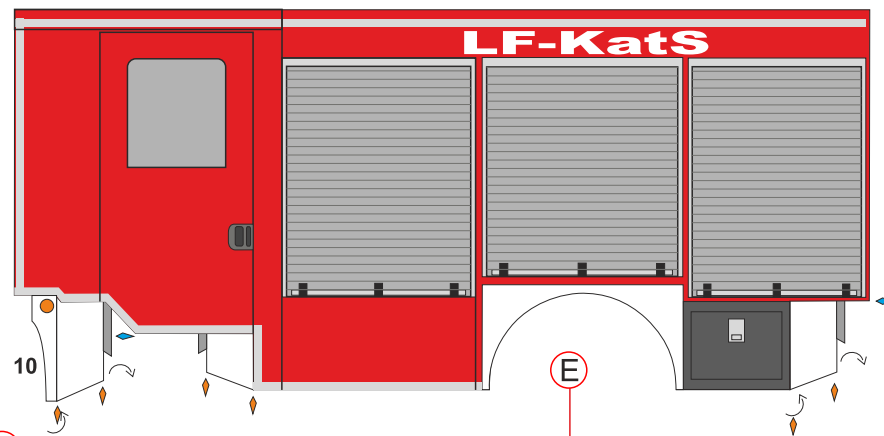
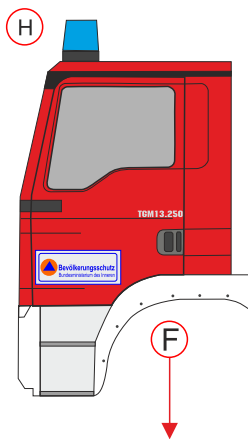

1/4

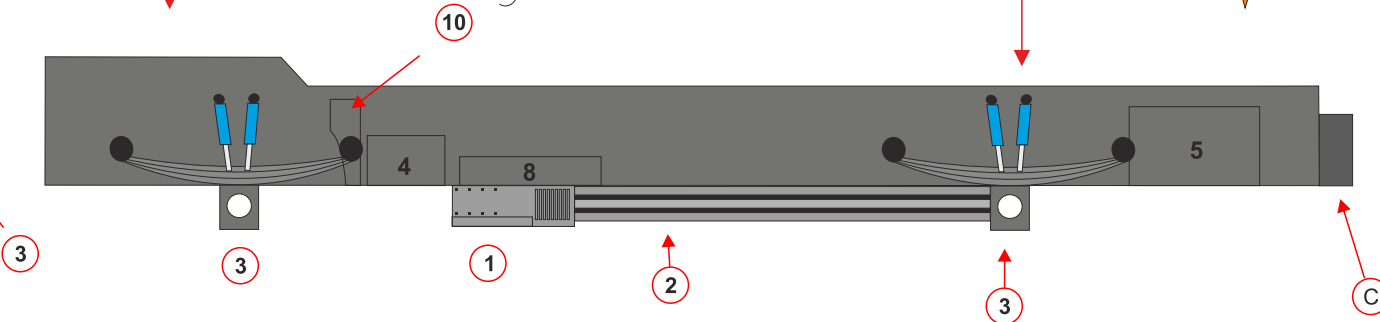
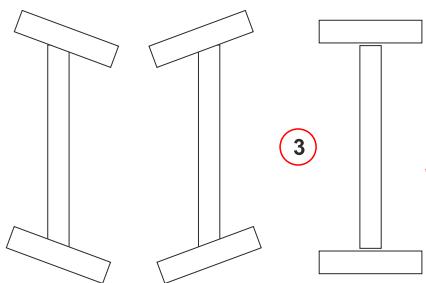

2/4

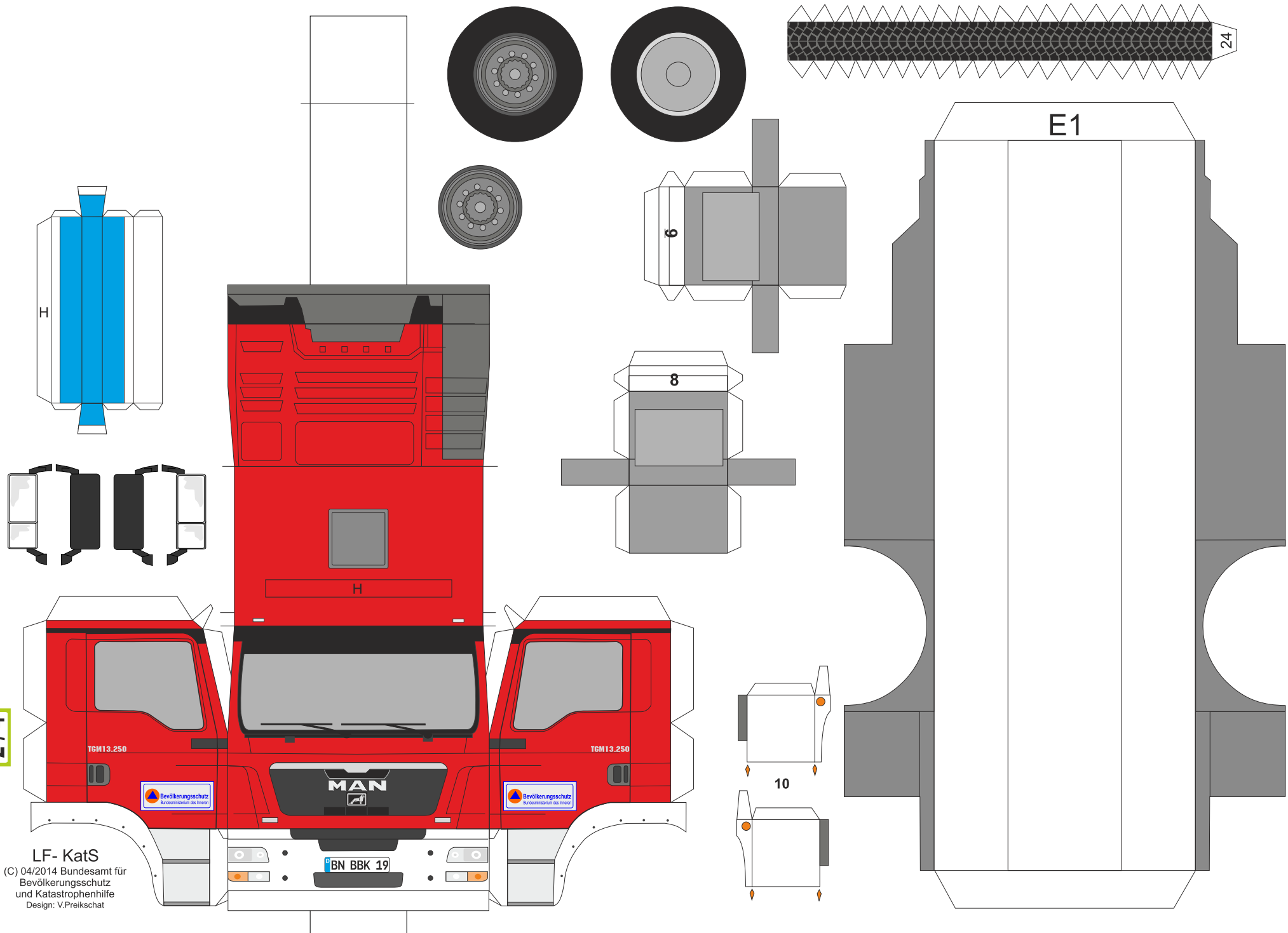

LF- Kats
 (C) 04/2014 Bundesamt für
 Bevölkerungsschutz
 und Katastrophenhilfe
 Design: V.Preikschat

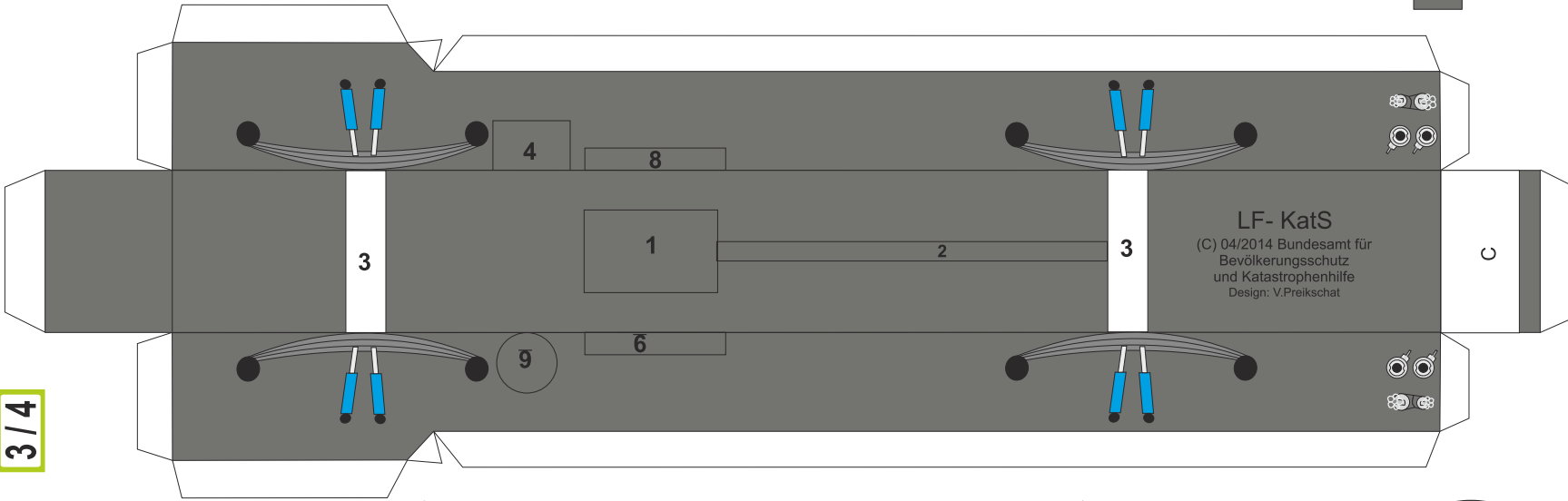
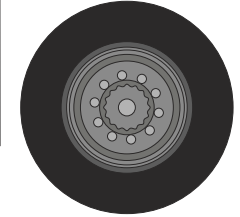
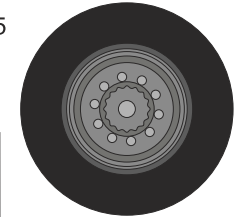
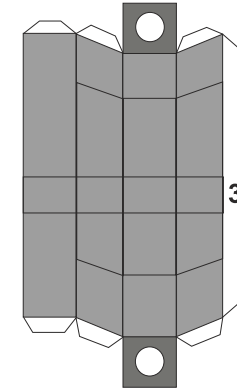
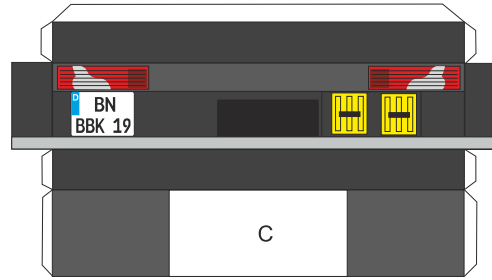
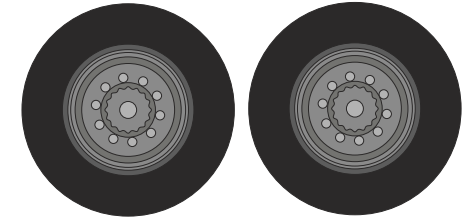
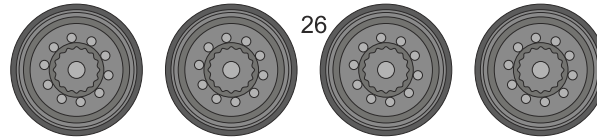
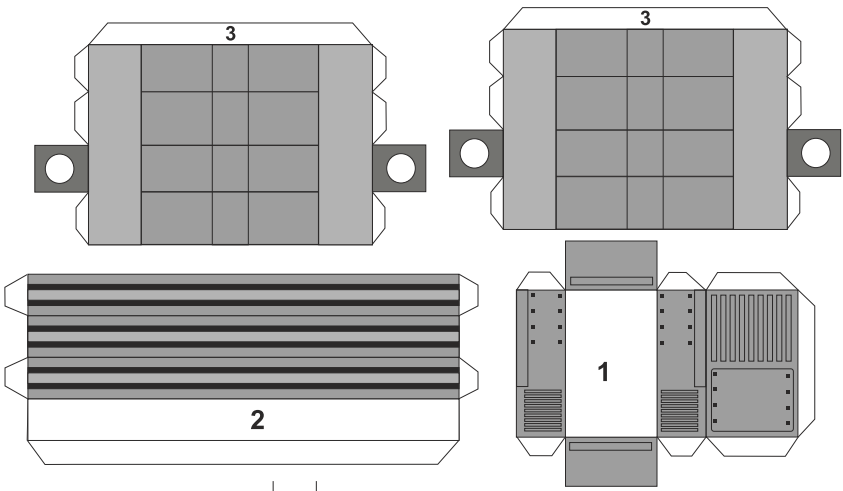

3/4

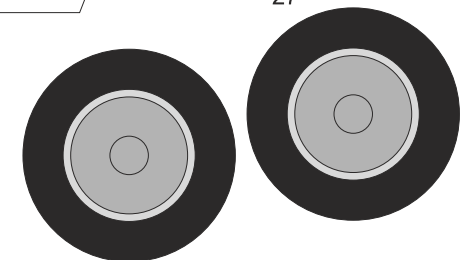
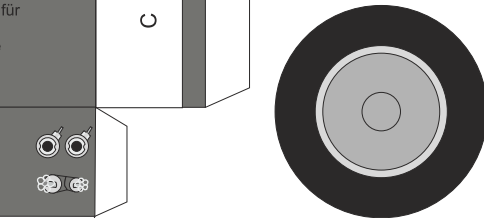
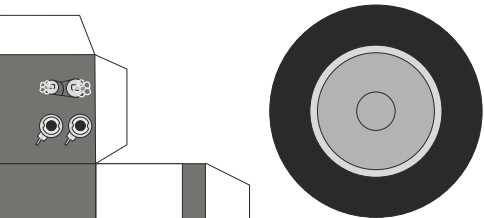
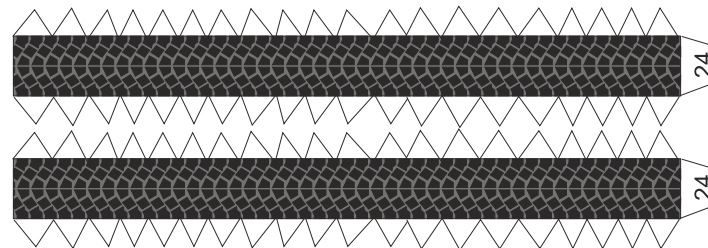
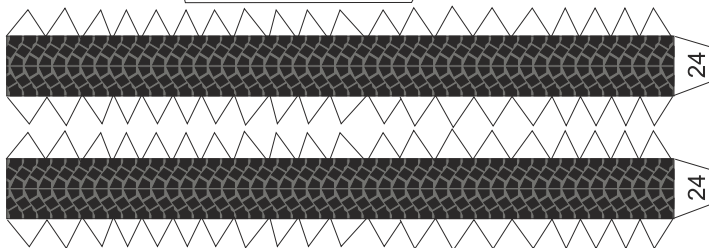

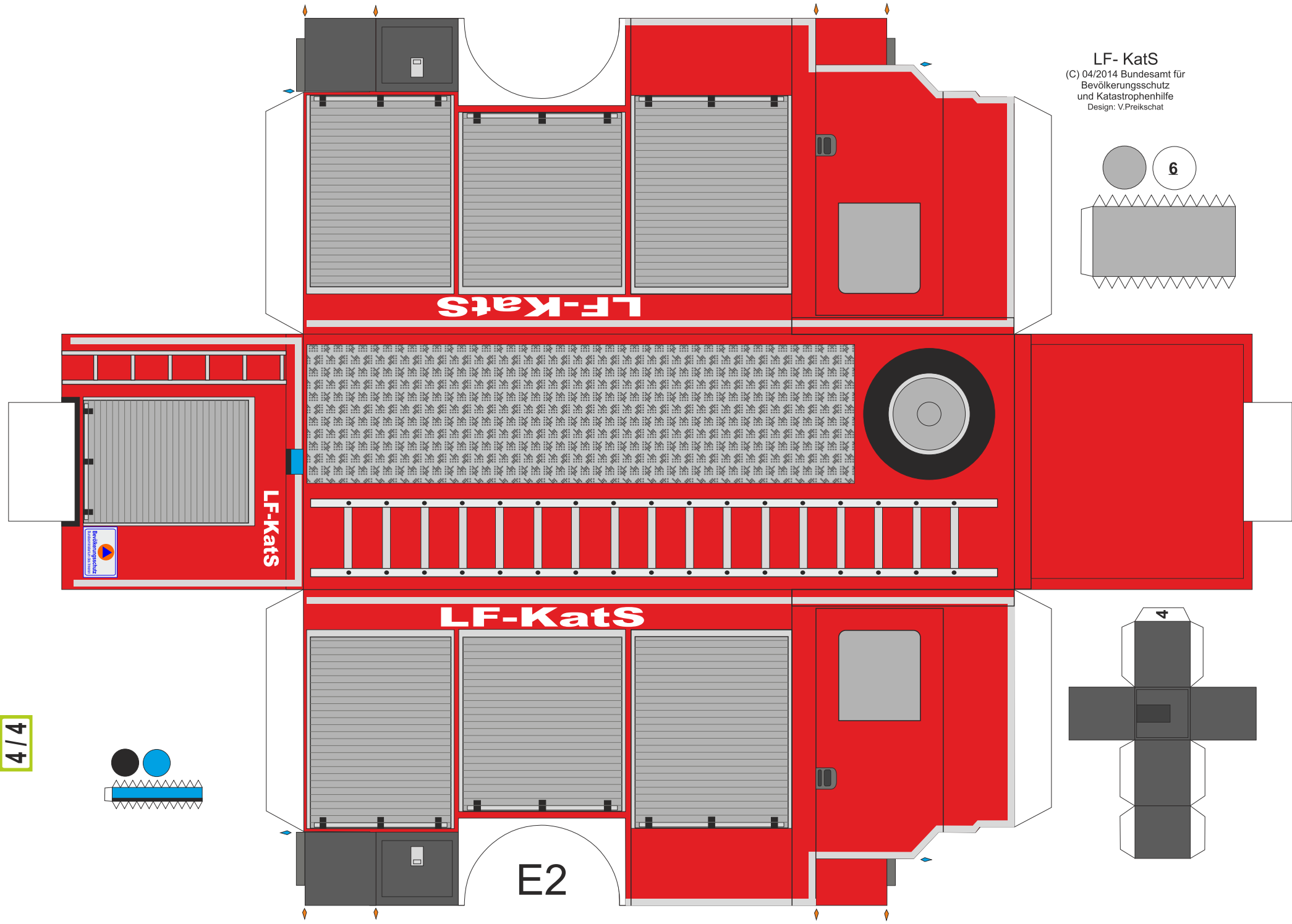

LF- KatS
(C) 04/2014 Bundesamt für
Bevölkerungsschutz
und Katastrophenhilfe
Design: V.Preikschat

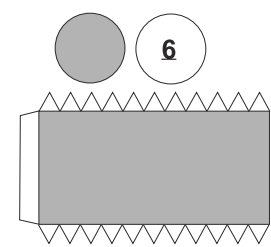

4/4

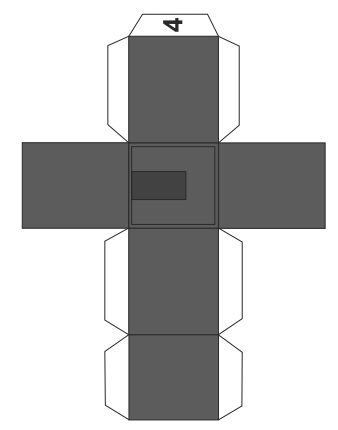
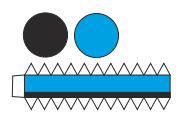

LF-KatS

LF-KatS

LF-KatS

E2

4